



# Camera crane **Jimmy Jib - OneMan**

## Camera crane **Jimmy Jib - OneMan**

The Camera crane **Jimmy Jib** can be operated by just one person. It can be assembled at different lengths and is easily transported.

### Facts.

Max. Lens Height:	27'8''
Max. Length:	39'7''
Total weight without camera:	Max. 1322 lbs (depending on set-up).
Max. camera weight:	58.64 lbs (depending on set-up).
Remote head:	Stanton-Head, 2 axes: Pan and tilt.
Control of remote head:	OneMan System.
Dolly:	Four-wheel steering, tracks incl. track wheels available. Alternatively, can tripod can be used.
Operating range:	Approx. 13' x 13' (depending on set-up and swivel range).
Features:	HD Monitors (broadcast reference monitor, camera preview monitor). Intercom system Clearcom with base station, beltpacks and headsets. Red light on the operating station.
Power Consumption:	Approx. 500 W

### Connectors.

2 cables with BNC plug:	1 for program image, 1 for camera preview.
3 cables with XLR plug:	2 x intercom for listening & speaking, 1 for red light.
2 power cables:	1 x 220 V Schuko on the operating station with its own 16 A-fuse.

# Camera crane Jimmy Jib - OneMan

## The views.

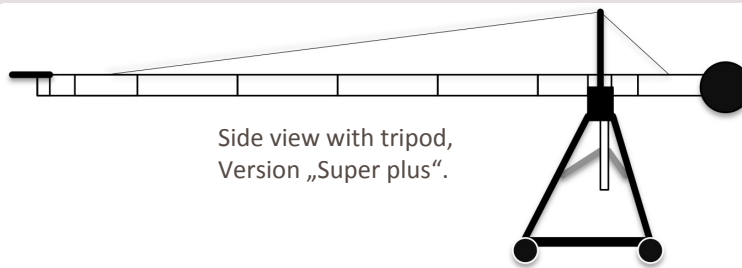

Side view with tripod,  
Version „Super plus“.

Max. Length from Dolly: 24'9"  
Max. Lens Height: 27'9"

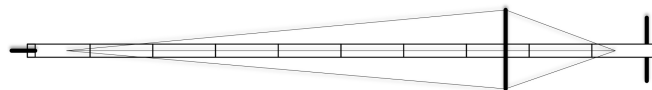

Version „**Super plus**“  
Max. Length: 30'8"

Max. Length from Dolly: 19'0"  
Max. Lens Height: 23'0"

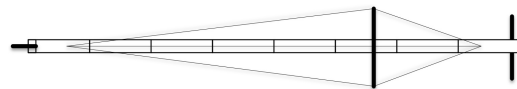

Version „**Super**“  
Max. Length: 24'9"

Max. Length from Dolly: 11'8"  
Max. Lens Height: 16'4"

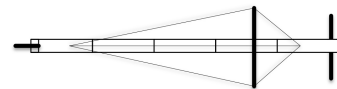

Version „**Giant**“  
Max. Length: 14'8"

Max. Length from Dolly: 5'8"  
Max. Lens Height: 10'8"

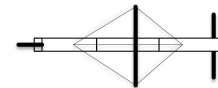

Version „**Standard**“  
Max. Length: 8'8"

The views.

Length and width including wheels: 4'1"

Track wheels available.

Total height: 4'5"

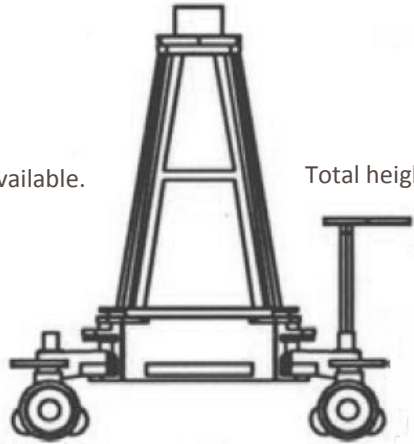

**Panther Dolly / Rail dolly**

Length and width including wheels: 2'9"

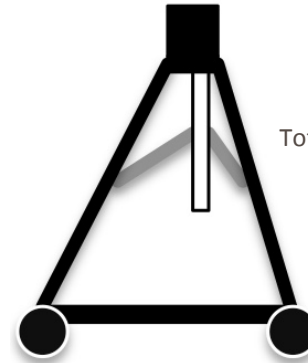

Total height: 5'4"

**Tripod**

## Contact.

OMD GmbH  
Optimale **Medien**Dienstleistungen  
Paradiesstrasse 208b  
12526 Berlin (Germany)

Fon: +49-30-67 89 55 01

Fax: +49-30-67 89 55 02

eMail: info@omd-gmbh.de

Web: www.omd-gmbh.de



[www.camera-crane.com](http://www.camera-crane.com)

## Legal Notice.

Managing Director: Mr. Maik Böhmer  
Local Court: Berlin-Charlottenburg  
Company Register Folio: HRB 138959  
Tax number: 37/461/31482  
VAT identification number: DE277097845