



Camera crane **Jimmy Jib**

Camera crane **Jimmy Jib**

The camera crane **Jimmy Jib** is the most commonly used fixed length camera crane. It can be assembled at different lengths and is easily transported.

Facts.

Max. Lens Height:	27'8''
Max. Length:	39'7''
Total weight without camera:	Max. 1322 lbs (depending on set-up).
Max. camera weight:	58.64 lbs (depending on set-up).
Remote head:	Stanton-Head, 3 axes: Pan, tilt and roll (Dutch roll 120 degrees).
Control of remote head:	Joystick.
Dolly:	Four-wheel steering, tracks incl. track wheels available. Alternatively, can tripod can be used.
Operating range:	Approx. 13' x 13' (depending on set-up and swivel range).
Features:	HD Monitors (broadcast reference monitor, camera preview monitor, swivel monitors). Intercom system Clearcom with base station, beltpacks and headsets. Red light on camera arm, on the swivel monitors and on the operating station.
Power Consumption:	Approx. 500 W

Connectors.

2 cables with BNC plug:	1 for program image, 1 for camera preview.
3 cables with XLR plug:	2 x intercom for listening & speaking, 1 for red light.
2 power cables:	1 x 220 V Schuko on the operating station with its own 16 A-fuse.

Camera crane Jimmy Jib

The views.

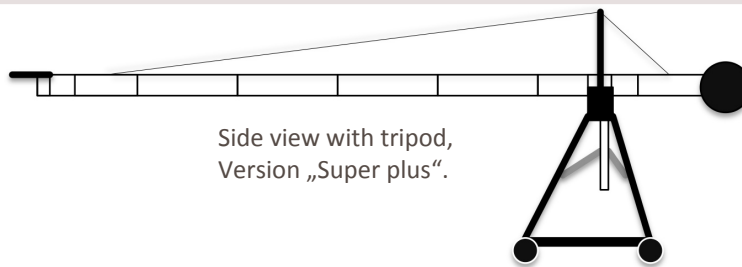

Side view with tripod,
Version „Super plus“.

Max. Length from Dolly: 30'9"
Max. Lens Height: 23'3"

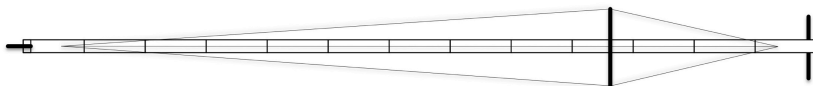

Version „Extreme“
Max. Length: 39'8"

Max. Length from Dolly: 24'9"
Max. Lens Height: 27'9"

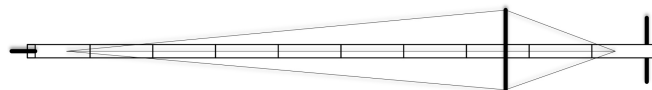

Version „Super plus“
Max. Length: 30'8"

Max. Length from Dolly: 19'0"
Max. Lens Height: 23'0"

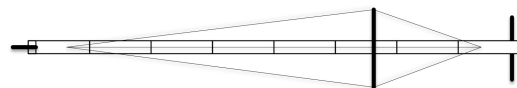

Version „Super“
Max. Length: 24'9"

Max. Length from Dolly: 11'8"
Max. Lens Height: 16'4"

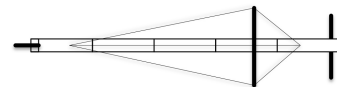

Version „Giant“
Max. Length: 14'8"

Max. Length from Dolly: 5'8"
Max. Lens Height: 10'8"

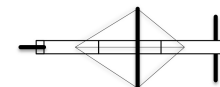

Version „Standard“
Max. Length: 8'8"

The views.

Length and width including wheels: 4'1"

Track wheels available.

Total height: 4'5"

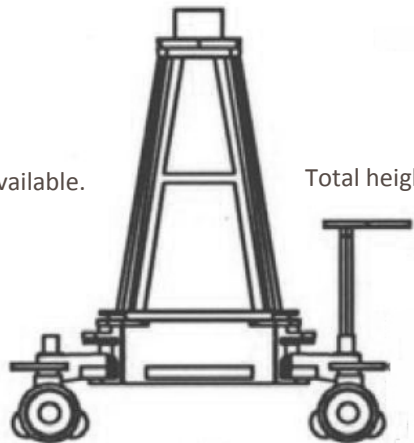

Panther Dolly / Rail dolly

Length and width including wheels: 2'9"

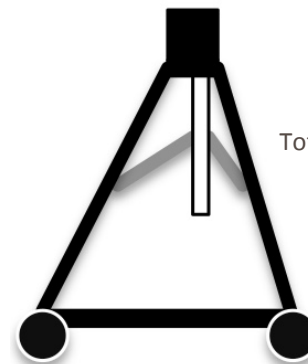

Total height: 5'4"

Tripod

Contact.

OMD GmbH
Optimale **Medien**Dienstleistungen
Paradiesstrasse 208b
12526 Berlin (Germany)

Fon: +49-30-67 89 55 01

Fax: +49-30-67 89 55 02

eMail: info@omd-gmbh.de

Web: www.omd-gmbh.de

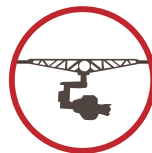

www.camera-crane.com

Legal Notice.

Managing Director: Mr. Maik Böhmer
Local Court: Berlin-Charlottenburg
Company Register Folio: HRB 138959
Tax number: 37/461/31482
VAT identification number: DE277097845